

MDF Italia interprets the outdoors: a journey of discovery through time and space with a collection capable of spanning completely different seasons and places thanks to furnishing systems that prove complete, integrated, and versatile.

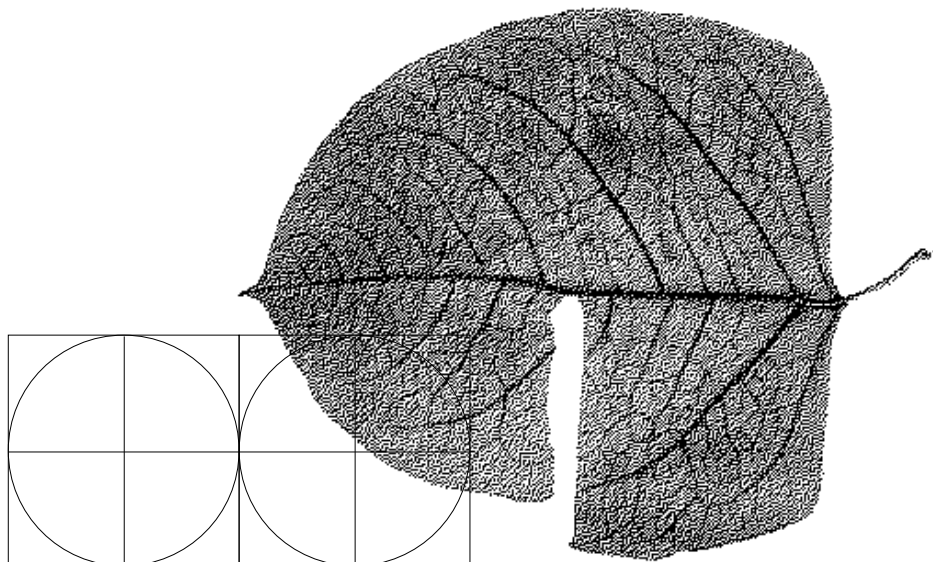

book 1 Indoor

book 2 Outdoor

book 3 Contract

book 4 News

mdf italia

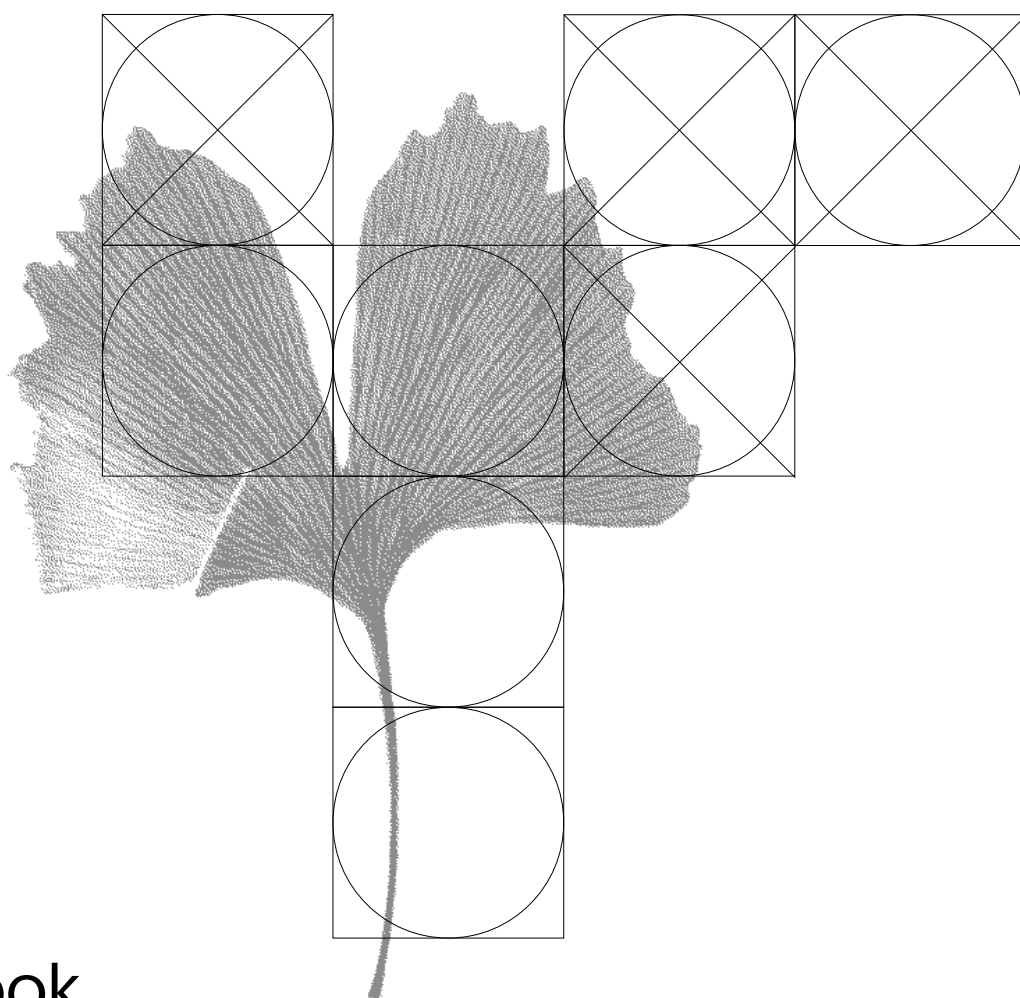

Outdoor book

Outdoor Index	Sofas	Chairs, armchairs, benches and stools	Tables and coffee tables
Introduction	2 Arpa collection	16 Flow collection	40 Axy 70
Outdoor collection	4 Cosy Outdoor	30 Flow Iroko	Fossil 72
Materials and finishings for Outdoor	6	Flow Filo	La Grande Table 74
Sustainability	10	Flow Stool	La Table Basse 78
			Offset 80
		Le Banc 46	
Technical sheets	104	M1 48	Rock Table collection 86
			Rock Table Round
		Neil collection 50	Rock Table Oval
		Neil Twist armchair	Rock Table Maxi
		Neil Twist chair	Rock Table Mini
		Neil Twist stool	
			Tense Outdoor 98
		Sag 62	
		Sign collection 64	
		Sign Matt chair	
		Sign Matt armchair	

↙ see also the other mdf italia printed volumes

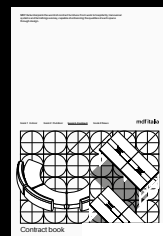
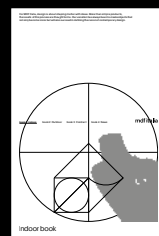

Outdoor book

mdf italia

^{EN} The Universe has its rules. The task of design is to recognize them and reiterate them, ensuring that the lines and volumes traced by human hands are the ideal fulfilment of nature's geometries. This is also our approach to outdoor furnishings. A selection of objects that are extraordinary for their versatility, compositional harmony, and quality of materials, which are inserted in public and private open spaces with respect and courage. Designer items that, in contact with the outdoor environment, become living organisms, nodes in a complex ecosystem and yet in perfect balance.

^{IT} L'universo ha i suoi canoni. Compito del design è riconoscerli e assecondarli, facendo sì che le linee e i volumi tracciati dalla mano dell'uomo siano l'ideale compimento delle geometrie della natura. Questo è anche il nostro approccio all'arredo outdoor. Una selezione di oggetti straordinari per versatilità, armonia compositiva e qualità dei materiali, che s'inseriscono con rispetto e allo stesso tempo con coraggio negli spazi aperti, pubblici e privati. Pezzi di design che a contatto con l'ambiente esterno si trasformano in organismi viventi, nodi di un ecosistema complesso eppure in perfetto equilibrio.



Sofas

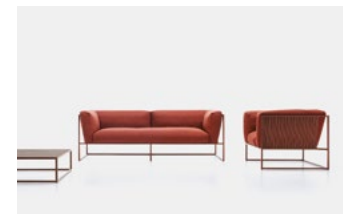

Arpa collection, p.16



Cosy Outdoor, p.30



M1, p.48

Chairs, armchairs, benches and stools

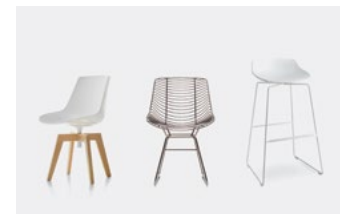

Flow collection, p.40

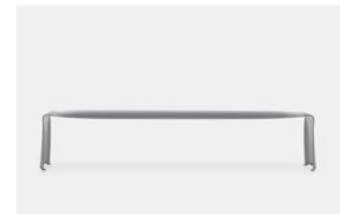

Le Banc, p.46



M1, p.48



Neil Twist collection, p.50



Sag, p.62



Sign collection, p.64

Tables and coffee tables



Axy, p.70



Fossil, p.72



La Grande Table, p.74



La Table Basse, p.78



Offset, p.80



Rock Table collection, p.86



Tense Outdoor, p.98

EN All outdoor products by MDF Italia feature top-quality materials, parts, and finishes designed to be weather resistant and last over time.

IT Tutti i prodotti per l'outdoor di MDF Italia sono caratterizzati da materiali, componenti e finiture eccellenti, pensati per resistere agli agenti esterni e durare nel tempo.

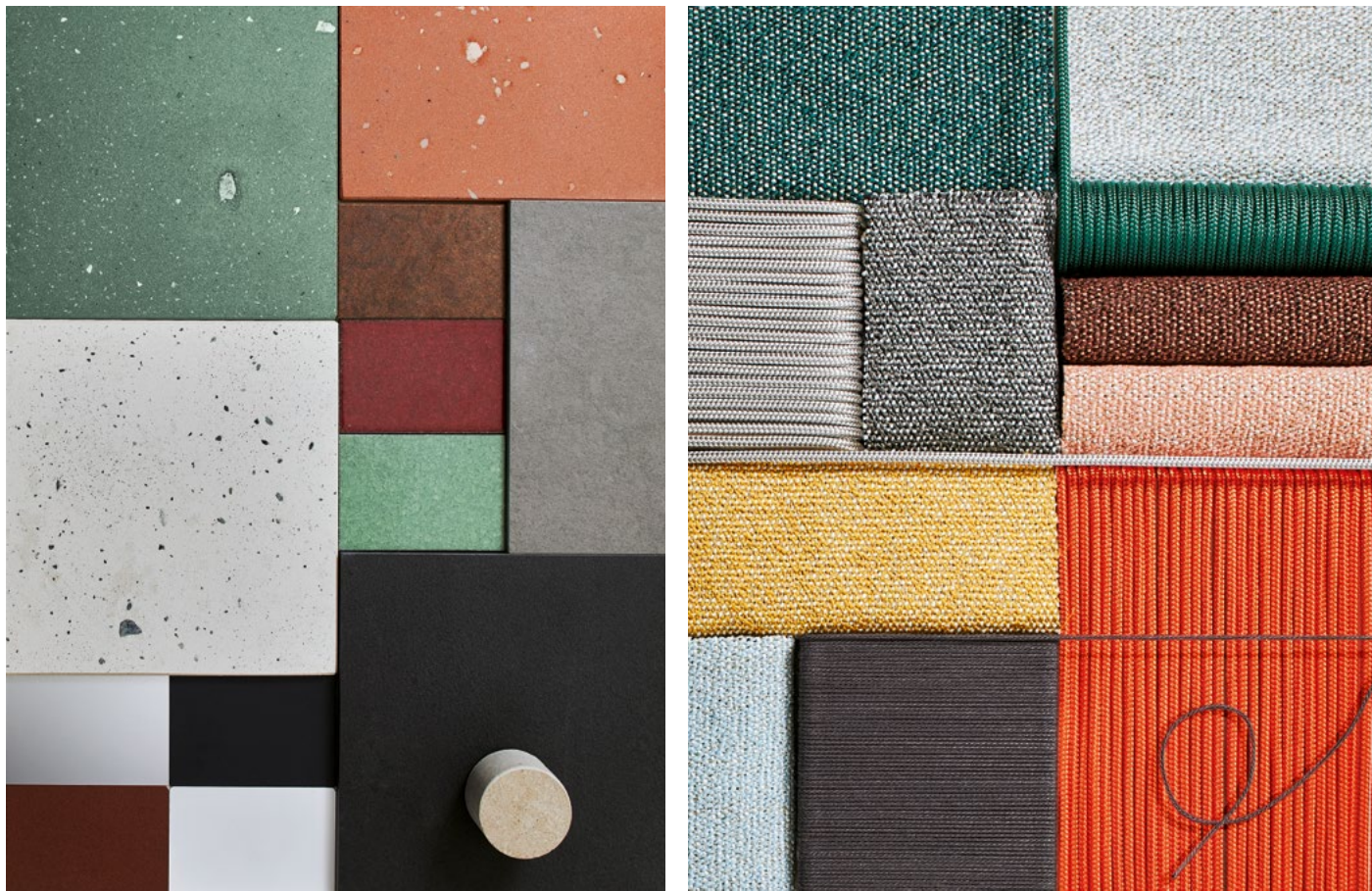

Cord

Composition: 100% Polypropylene
 Weight: 13.5 gr/mtl
 Diameter: 5 mm
 Xenotest lights: UNI EN ISO 105:B2 / 6
 Sea water: UNI EN ISO 105:E2 / 4/5
 Swimming pool water: UNI EN ISO 105:E3 / 4/5
 Dry rubbing: UNI EN ISO 105:X12 / 4/5
 Wet rubbing: UNI EN ISO 105:X12 / 4/5

Ramiro fabric

Composition: 100% PP - TEN STARS YARN Exclusive patented yarn
 Height: 138 cm
 Weight: 880 gr/mtl
 Light fastness: 7 UNI EN ISO 105:B2
 Resistance to machine hand washing; sea water: UNI EN ISO 105:E2 / 5
 Resistance to chlorinated swimming pool water: UNI EN ISO 105:E3 / 4/5
 Pilling: 5 UNI EN ISO 12945-2
 Martindale: 50.000 UNI EN ISO 12947-2
 Fire resistance: BS 5852 part 1:1979 cigarette test

Delta fabric

Composition: 188% Polypropylene - 20% Polyester
 Height: 140 cm
 Weight: 814 g/lm
 Light fastness: 7/8 UNI EN ISO 105:B2
 Pilling: 4/5 UNI EN ISO 12945-2
 Martindale: 80.000 UNI EN ISO 12947-2
 Fire resistance: BS 5852 part 1:1979 cigarette test
 TB 117-2013 / Cigarette BS5852.1.1979
 100% Recyclable.
 100% Non toxic (EU and USA standard).
 Anti-allergic.
 Resistant to fungus, bacteria, sunlight, humidity, chlorine, food stains and sweat.
 Compatible with delicate baby skin.
 Eco-friendly (low energy for cleaning, long lasting life cycle, easy to use).

Cement UHPFRC

Composition: Cement
 Weight: 2300 kg/mc
 Compressive strength: 100 MPA
 Bending resistance 13-16 MPA
 Freeze and thaw: Irrelevant
 Porosity: 10%
 Thermal Shock: Resistant
 Fire resistance: EN 13501-1 / A2-S1-B0
 Rock Table: EN 12720 / A / Assessment of surface resistance to cold liquids / 4787488045

Aluminium

EPOXY PAINTED ALUMINIUM:
 TGIC-FREE / Stardast Lead Black Powder - Offset
 Composition: 100% Polyestere
 Average thickness: 60 - 90 Micron
 Shine 60°: EN ISO 2813 / 10/15 Gloss
 Saline mist: EN ISO 9227 / <4 mm - 1000 Hours
 Water-and boiling-resistance: EN 12206 / No Defect
 Erichsen Padding: EN ISO 1520 / >5 mm
 Buchholz durometer: EN ISO 2815 / >80
 Shock resistance: EN ISO 6272 / No damage at 2,5 nm
 Bending: EN ISO 1519 / No damage with D. 5mm

Iroko wood

Flow Iroko: Iso 9227 / No Defect /
 Saline mist: Iso 9227 1000h /
 4789361797

Porcelanised Grès

Composition: Grès Porcelanised
 Weight: 6 Mm Kg/Mq
 Bending strength: ISO 10545-4 / 50-53 MPA
 Freeze resistance: UNI EN ISO 10545.12 / Resistant
 Abrasion resistance: UNI EN ISO 10545.6 / ≤ 142 Mm³
 Thermal shock: UNI EN ISO 10545.9 / Resistant
 Chemical resistance: UNI EN ISO 10545.13 / Resistant
 Fire resistance: 96/603/CE /A1

Reconstructed stone

Pietra Serena: EN 12720 / B / Assessment of surface resistance to cold liquids / 4787363370
 Pietra: ISO 9227 / No Defect / Saline mist ISO 9227 1000H

Steel

INOX 316 POWDER COATED: TGIC-FREE / Arpa structure
 Composition: 100% Polyestere
 Average thickness: 60 - 90 Micron
 Shine 60°: EN ISO 2813 / 6/9 Gloss
 Saline mist: EN ISO 9227 / 500 h without Film Detachment
 Water-and boiling-resistance: EN 12206 / No Defect
 Erichsen Padding: EN ISO 1520 / 7 Mm
 Shock resistance: EN ISO 6272 / No damage at 2,5 nm
 Bending: EN ISO 1519 / No damage with d. 6 mm

Plastics

Material: Polyethylene
 Density: 0,934 G/cm3
 Tensile Yield Strength: ASTM D 638 / 18 MPA
 Flexural modulus: ASTM D 790 / 550 MPA
 Hardness: Shore / 57
 Fire resistance: Upon request

Lexan: Flow
 Material: Lexan Resin 103r
 Density: 1,2 G/Cm3
 Tensile Yield Strength: ISO 527 / 63 MPA
 Flexural modulus: ISO 178 / 2300 MPA
 Indentation: ISO 2931-1 / 95 MPA
 Fire resistance: Upon request
 Flow - Chair shell: ISO 9227 / No defect**

Polypropylene: M1
 Material: Polypropylene
 Density: 1,12 G/cm3
 Tensile Yield Strength: ASTM D 638 / 26
 Flexion Module: ASTM D 790 / 1900 MPA
 Indentation: IZOD / 60 J/M
 Fire resistance: Upon request



ISO 14001

MDF Italia demonstrates its commitment to sustainability through ISO 14001 certification, internationally recognised as the reference standard for environmental management systems. A significant achievement, which marks the beginning of a dynamic path towards greater sustainability in our business processes.

MDF Italia dimostra il suo impegno per la sostenibilità attraverso la certificazione ISO 14001, riconosciuta a livello internazionale come lo standard di riferimento per i sistemi di gestione ambientale. Un traguardo significativo, che segna l'inizio di un percorso dinamico verso una maggiore sostenibilità nei nostri processi.



Responsible design

MDF Italia creates objects that have the ambition to transcend fashion and last over time, a characteristic that leads them to be intrinsically sustainable. Today, this design attitude leads to a series of responsible choices in the field of materials, development and eco-design. In particular, we use wood exclusively from responsibly managed forests, flexible polyurethane of which more than half is made from recycled raw materials, and plastics that are either recycled or obtained from environmentally responsible processes. We design our products so that at the end of their life cycle they can be disassembled, thus facilitating a proper recycling process.

MDF Italia realizza oggetti che hanno l'ambizione di trascendere le mode e durare nel tempo, una caratteristica che li porta a essere intrinsecamente sostenibili. Oggi, quest'atteggiamento progettuale sfocia in una serie di scelte responsabili nel campo dei materiali, della progettazione e dell'eco-design. In particolare utilizziamo legno proveniente esclusivamente da foreste gestite in modo responsabile, poliuretano flessibile realizzato con più della metà di materia prima riciclata e plastiche riciclate o ottenute da processi rispettosi dell'ambiente. Progettiamo i nostri arredi per far sì che al termine del loro ciclo di vita possano essere disassemblati, facilitando così un adeguato processo di riciclo.

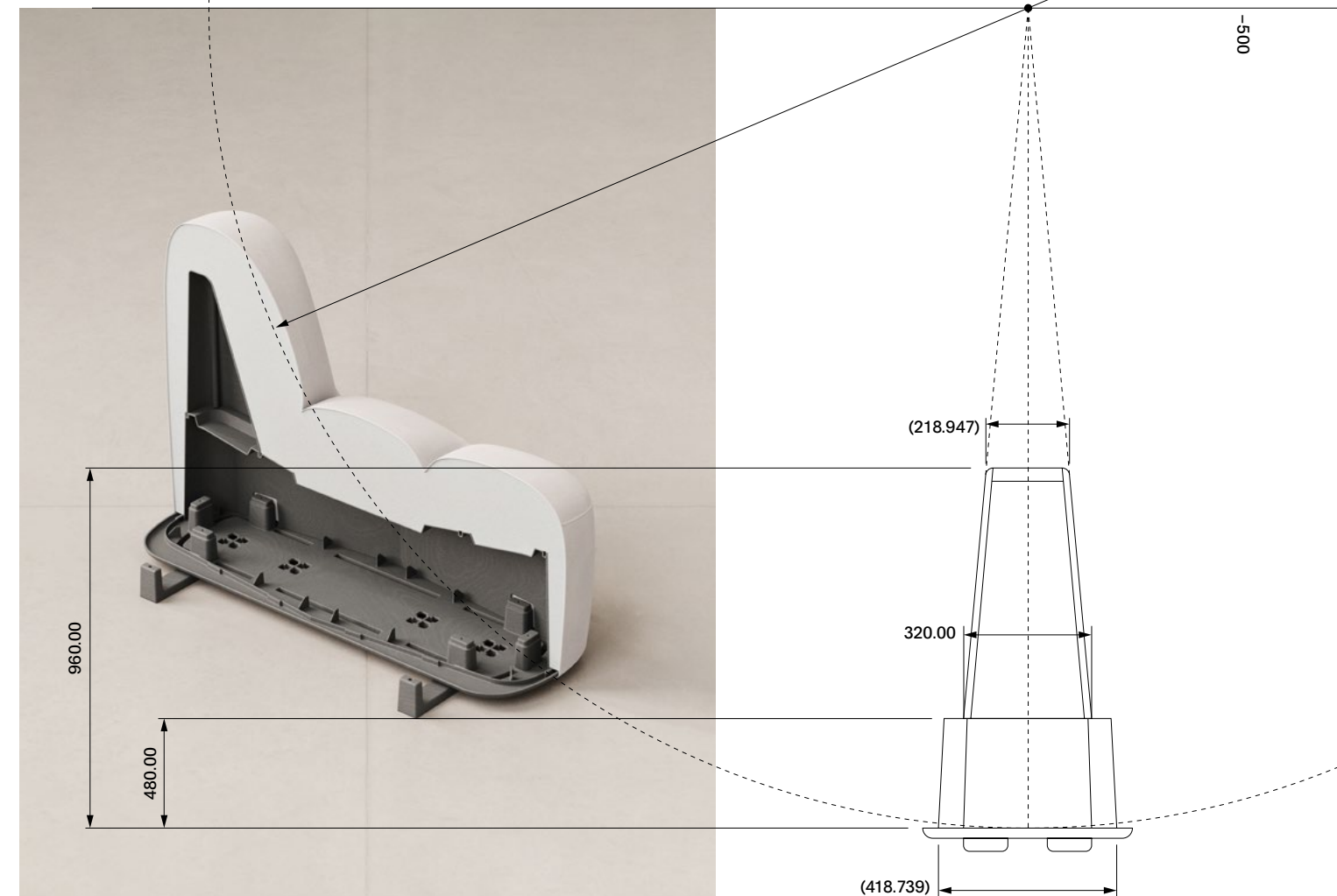

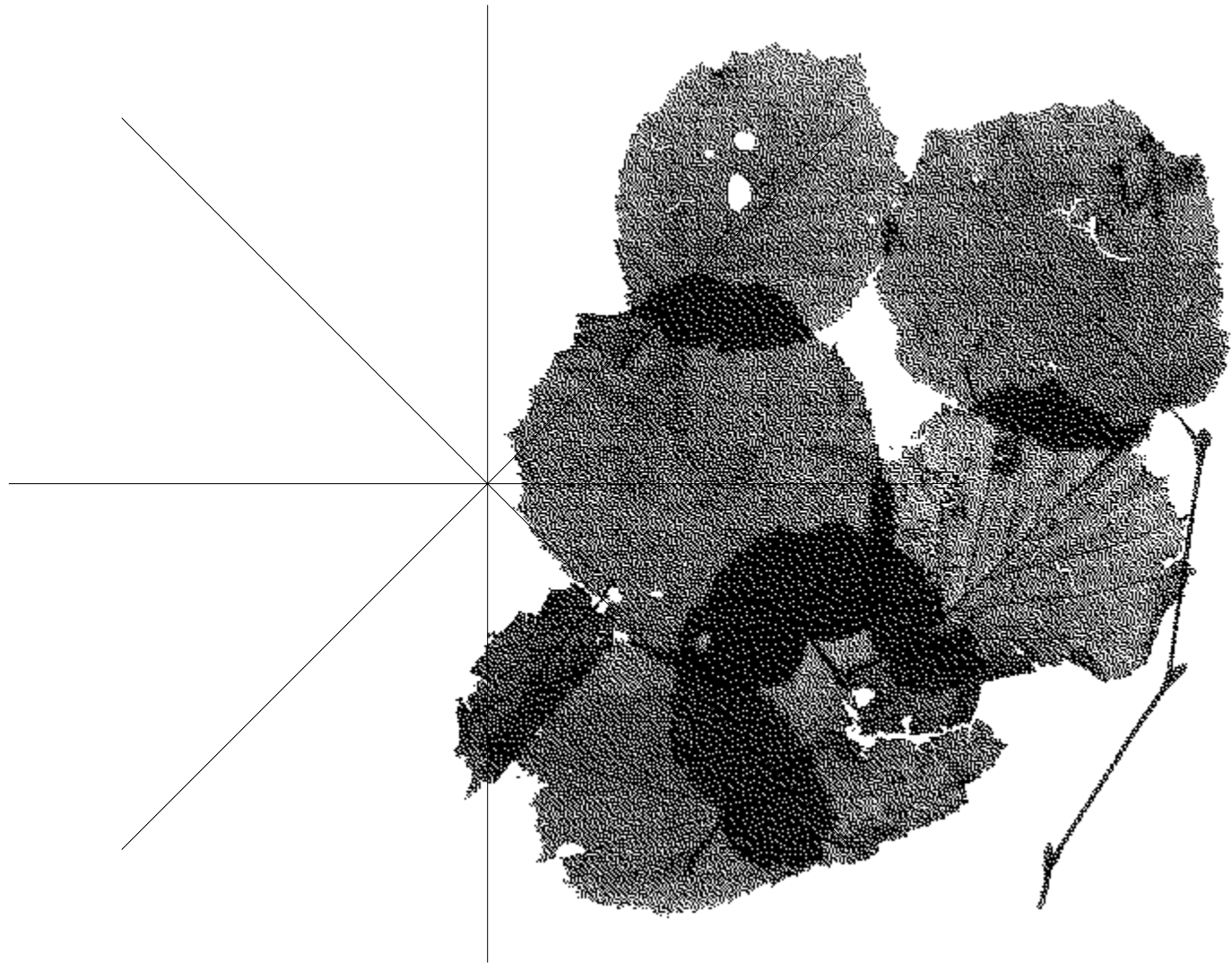



Arpa sofa
Arpa sofa corner
Arpa armchair
Arpa low table

Arpa collection

Designed by Ramón Esteve Estudio

← Arpa armchair ecrù Ramiro fabric, matt white goffered painted structure and matt ecrù grey cord.



1

EN Stylistic research, refined aesthetics without neglecting comfort and functionality: these are the hallmarks of Arpa collection designed by Ramón Esteve. This iconic collection name was inspired by the musical instrument. It is a system that provides possible infinite combinations using different elements - sofas, armchairs, and corner modules. The refined ropes add elegance and delicacy to each element, providing a feeling of lightness, as if the upholstery were floating suspended from its structure. The pouf and coffee table complete the collection.

IT Ricerca stilistica, raffinata estetica senza tralasciare comfort e funzionalità: questi sono i tratti distintivi della collezione Arpa disegnata da Ramón Esteve. L' iconica collezione, che deve il suo nome allo strumento musicale, al quale si ispira, si propone come un vero e proprio sistema che offre la possibilità di creare infinite combinazioni grazie ai diversi elementi a disposizione: divani, poltrone, e moduli angolari. Le raffinate corde aggiungono eleganza e delicatezza a ogni elemento della famiglia donando una sensazione di leggerezza, come se l'intero rivestimento galleggiasse sospeso dalla propria struttura. Completano la collezione il pouf e il tavolino.

1 Previous page: Detail of the refined cords that add elegance to the sofa and armchair.

2 Arpa sofa in dark orange Ramiro fabric and matt corten goffered painted structure.

→ Arpa armchair and low table with matt light grey calce ceramic top.



2





← Arpa sofa, armless and backless, with seat cushions and optional moveable back cushions.

3 Arpa sofa solution with repositionable cushions.



3





1



2



3



4

1-4 Arpa collection: different configurations with corner sofa, armchair, low table and pouf.





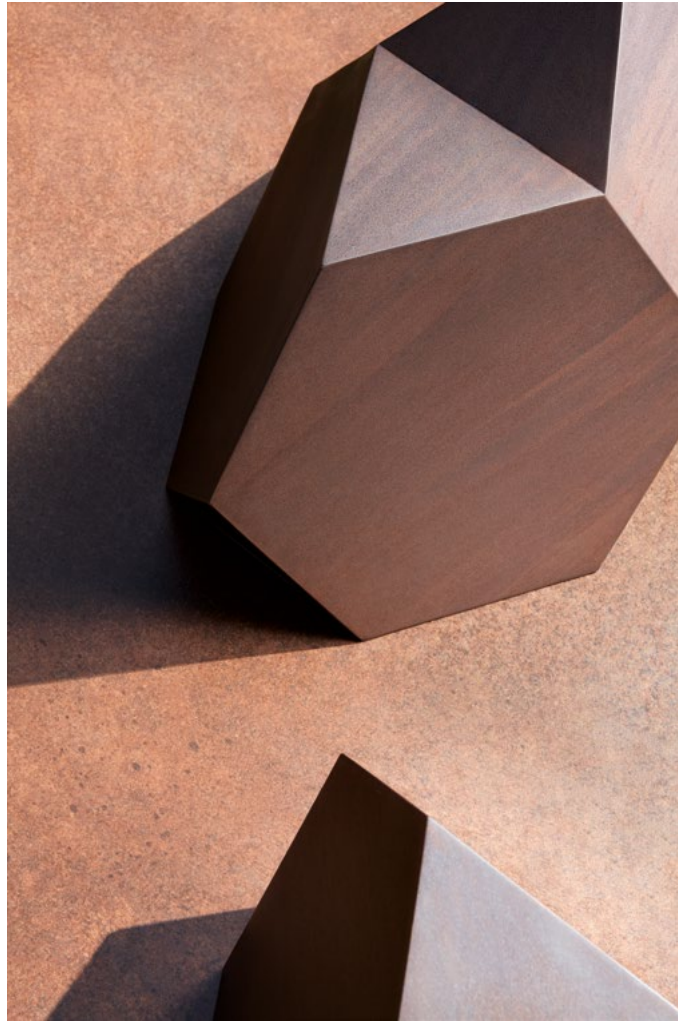

→ Arpa collection, three-seater sofa, armchair and low table.



Cosy Outdoor

Designed by Francesco Rota



← Cosy Outdoor sofa in Delta fabric with 316 stainless steel structure.

→ Detail of the 316 stainless steel structure.



Rock Table collection

EN Created by Francesco Rota, Cosy is a sofa system with an enveloping design and large, soft cushions. With its curved or linear modules, the outdoor and indoor versions have the same strengths - modularity and freedom of composition that allow for different configurations. The outdoor range's distinguishing feature is its 316 stainless steel structures that support the cushions and provide the collection with personality. Ideal for furnishing outdoor spaces, in residential, contract and hospitality settings.

IT Nato dalla mano di Francesco Rota, Cosy è un sistema di divani caratterizzato da un design avvolgente e da grandi e morbide cuscinate. Nella sua evoluzione outdoor si riscontrano gli stessi punti di forza della versione indoor: modularità e la più totale libertà compositiva grazie ai moduli curvi o lineari che consentono di dare vita a diverse configurazioni. Il tratto distintivo della proposta outdoor risiede nelle strutture in acciaio inox 316 che svolgono al contempo una funzione di sostegno alle cuscinate e donano alla collezione un tratto identitario. Ideale per arredare tutti gli spazi all'aria aperta, sia in ambito residenziale sia legato nei mondi contract e hospitality.

→ Cosy Outdoor sofa corner configuration in Delta fabric.



La Table Basse





← Cosy Outdoor, curved module with painted matt lead black structure.



Rock Table collection





1

1 Cosy Outdoor, detail of Delta fabric and 316 stainless steel structure.

2 Cosy Outdoor, configuration combining different modules: S, M and L.



3

3/4 Cosy Outdoor with curved seating and back cushions.



2



4

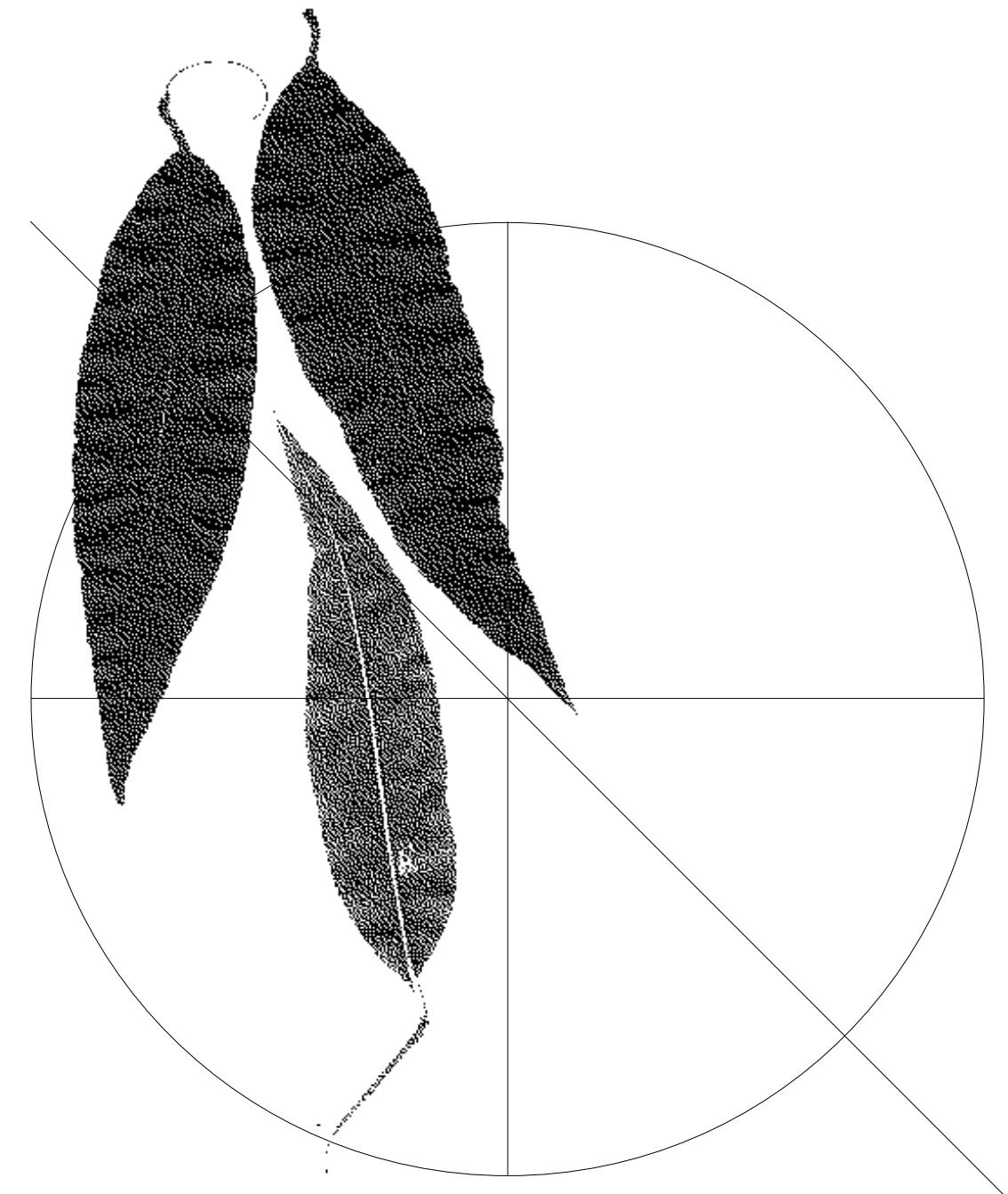

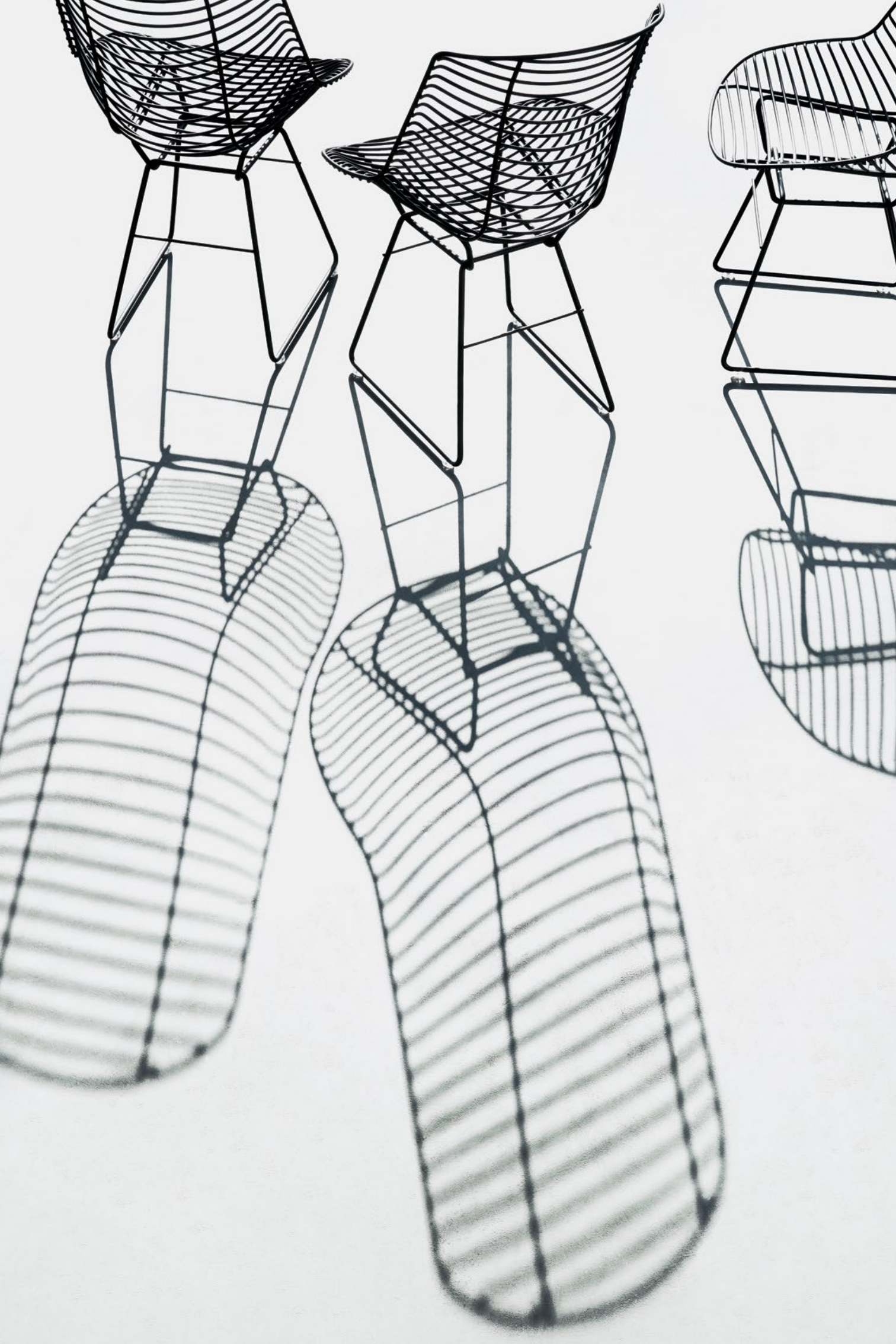

Flow Filo
Flow Iroko
Flow Stool

Flow collection

Designed by Jean Marie Massaud

← Flow Filo chair
outdoor finishes.



1

EN Designed by Jean Marie Massaud, the Flow collection has evolved, but is still faithful to its distinguishing elegance and lightness. In its outdoor version, the unmistakable silhouette is unchanged but introduces materials and technologies suitable for outdoor environments. Iroko wood, a weather-resistant African wood, is the constituent element of the swivel base, perfectly combined with the white in the Flow Chair Iroko version. Flow Filo, with its high-quality craftsmanship, achieved by welding together its thin steel wires, in a perfect combination of design and artistry.

IT Progettata da Jean Marie Massaud, la collezione Flow nel tempo si è evoluta, rimanendo sempre fedele ai principi di eleganza e leggerezza che l'hanno contraddistinta. Nelle sua declinazione outdoor, l'inconfondibile silhouette rimane immutata ma introduce materiali e tecnologie adatti agli ambienti esterni. Il legno di Iroko, legno africano resistente agli agenti atmosferici, è l'elemento costitutivo del basamento girevole, perfettamente combinato alla scocca nella versione Flow Chair Iroko. Flow Filo, invece, si caratterizza per la preziosa artigianalità della sua lavorazione, ottenuta saldando insieme i sottili fili d'acciaio di cui è composta, in un perfetto connubio tra design e artigianalità.

1 Previous page: Flow Filo Slim with polyurethane optional pad.

→ Flow Filo Chair, matt painted black nickel.

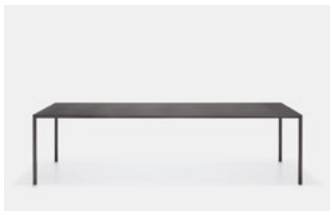

Tense Outdoor





2

← Flow Chair Iroko with white shell and Iroko wood base.



3

2 Flow Stool with sled base.

3 Flow Chair Iroko white shell with 4 legged base in solid Iroko, swivel 360°.



Tense Outdoor

Le Banc

Designed by Xavier Lust

EN Designed by Xavier Lust, Le Banc combines material and function in a sculptural product. Light and slender, this outdoor bench is made of a single sheet of curved and painted aluminium. Its unmistakable silhouette, determined by its 6-mm thickness, fits casually into public spaces and private homes.

IT Progettata da Xavier Lust, Le Banc unisce materia e funzione in un prodotto scultura. Icona leggera e sottile, questa panca per outdoor è costituita da un'unica lastra di alluminio curvata e poi verniciata. La sua silhouette inconfondibile, dettata dallo spessore di soli 6mm, si inserisce con disinvoltura in spazi pubblici e residenze private.



← Le Banc gloss painted red aluminium.

1 Le Banc matt painted aluminium.

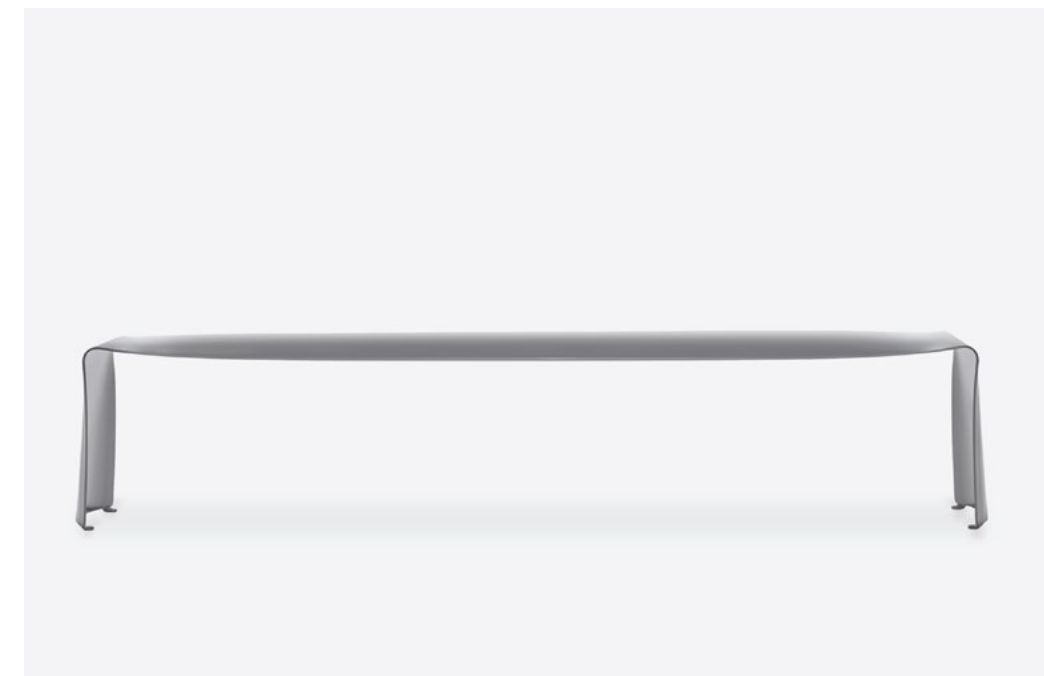

1



M1

Designed by Piergiorgio Cazzaniga

EN Piergiorgio Cazzaniga's M1 chair combines essentiality and informal elegance. Available with a stainless steel or matt white painted base and white plastic shell, this chair is for outdoor environments. Extremely flexible and versatile, M1 fits into residential and contract environments. Easily stackable up to 16 units, M1 chairs can be easily stored to save space.

IT Essenzialità ed eleganza informale si fondono in M1, sedia di Piergiorgio Cazzaniga. Disponibile con basamento in acciaio inox oppure verniciato opaco bianco e scocca bianca in plastica, questa seduta costituisce una proposta per ambienti outdoor. Estremamente flessibile e versatile, M1 si integra sia in contesti residenziali che contract. Facilmente impilabili fino a 16 unità, le sedie M1 possono essere riposte con estrema facilità per non occupare spazio.

← M1 white shell and matt white painted base.

1 Easily stackable up to 16 units.



Tense Outdoor



1



Neil Twist armchair
Neil Twist chair
Neil Twist stool

Neil Twist collection

Designed by Jean Marie Massaud

EN The Neil Twist collection responds to outdoor needs with elegance and lightness, combining iconic design, essentiality and comfort. The load-bearing steel structure is wrapped in an exclusive polyester rope weave, which is the collection's distinctive and identifying feature and consists of chair, armchair and stool. The many colour variants integrate harmoniously into different public or private outdoor areas.

IT La collezione Neil Twist risponde con eleganza e leggerezza alle esigenze outdoor, combinando design iconico, essenzialità e comfort. La struttura portante in acciaio è avvolta da un intreccio esclusivo con corda di poliestere, che costituisce il tratto distintivo e identitario dell'intera collezione, composta da sedia, poltrona e sgabello. Le diverse varianti cromatiche disponibili si integrano in modo armonico a diversi contesti outdoor, pubblici oppure privati.

← Neil Twist armchair with glossy English green cord weave and painted matt lead black structure.



1

1 Neil Twist armchair with matt ecru cord weave and matt painted white structure.



2

2 Neil Twist armchair matt ecru cord weave and painted matt lead black structure.

→ Neil Twist armchair with armrests in glossy English green cord weave and painted matt lead black structure.





3

← Neil Twist armchair with glossy orange cord weave and painted matt lead black structure.

3 Neil Twist armchair, contrasting stitching detail in anthracite colour.



Fossil



→ Neil Twist chair with glossy English green cord weave and painted matt lead black structure.



Rock Table collection



→ Neil Twist chair with matt anthracite grey cord weave and painted matt lead black structure.





← Neil Twist stool with matt ecru grey cord weave and matt painted white structure.

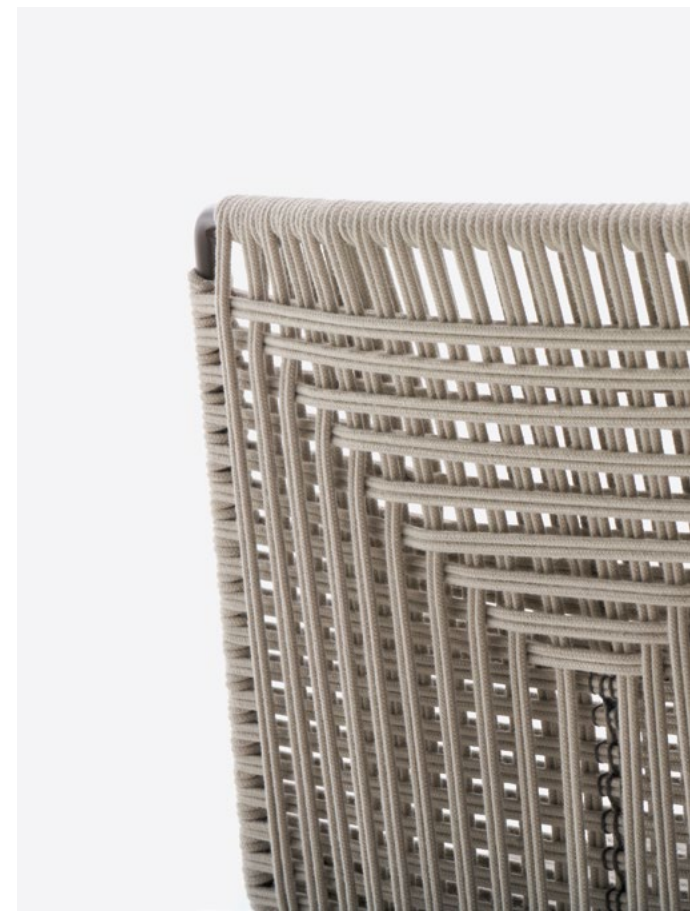

4

4 Neil Twist stool detail, matt ecru

5 Neil Twist, overview of the entire collection.



5



Sag

Designed by Nendo

EN Sag can be used as a small table or seat and is a dynamic complement that fits naturally into any outdoor setting - gardens, terraces, and dehors. Made of polyurethane and available in white or mud colours, Sag provides an original interpretation of the traditional stool with a dynamic and fluid shape.

IT Sag, utilizzabile come tavolino o seduta, è un complemento dinamico che si inserisce con naturalezza in ogni ambiente outdoor: giardini, terrazze, dehors. Realizzato in poliuretano e disponibile nei colori bianco o fango, Sag reinterpreta con originalità il tradizionale sgabello con una forma dinamica e fluida.

← Sag white
polyurethane version.

1 Sag mud
polyurethane version.



1



Sign Matt chair
Sign Matt armchair

Sign collection

Designed by Piergiorgio Cazzaniga

EN Piergiorgio Cazzaniga's Sign Matt is a sculptural seat with organic and fluid forms. Its proportions and volumes are designed to guarantee maximum comfort for the chair and armchair versions. Available in several colours with a matt finish, Sign is perfect for furnishing any outdoor environment and creating an open-air living space.

IT Sign Matt di Piergiorgio Cazzaniga è una seduta scultorea, dalle forme organiche e fluide. Le sue proporzioni e volumi sono studiati per garantire il massimo comfort, sia che si tratti della versione sedia che poltrona. Disponibile in diverse cromie con finitura opaca, Sign è perfetta per arredare qualsiasi ambiente outdoor e creare un living all'aperto.

← Sign Matt armchair matt white colour.



1

1 Sign Matt collection, armchair and chair versions.

2 Sign Matt chair matt white colour.

3 Sign Matt chair matt cement colour.



4

4 Sign Matt armchair matt white colour.

5 Sign Matt chair matt mud colour.



2



3



5

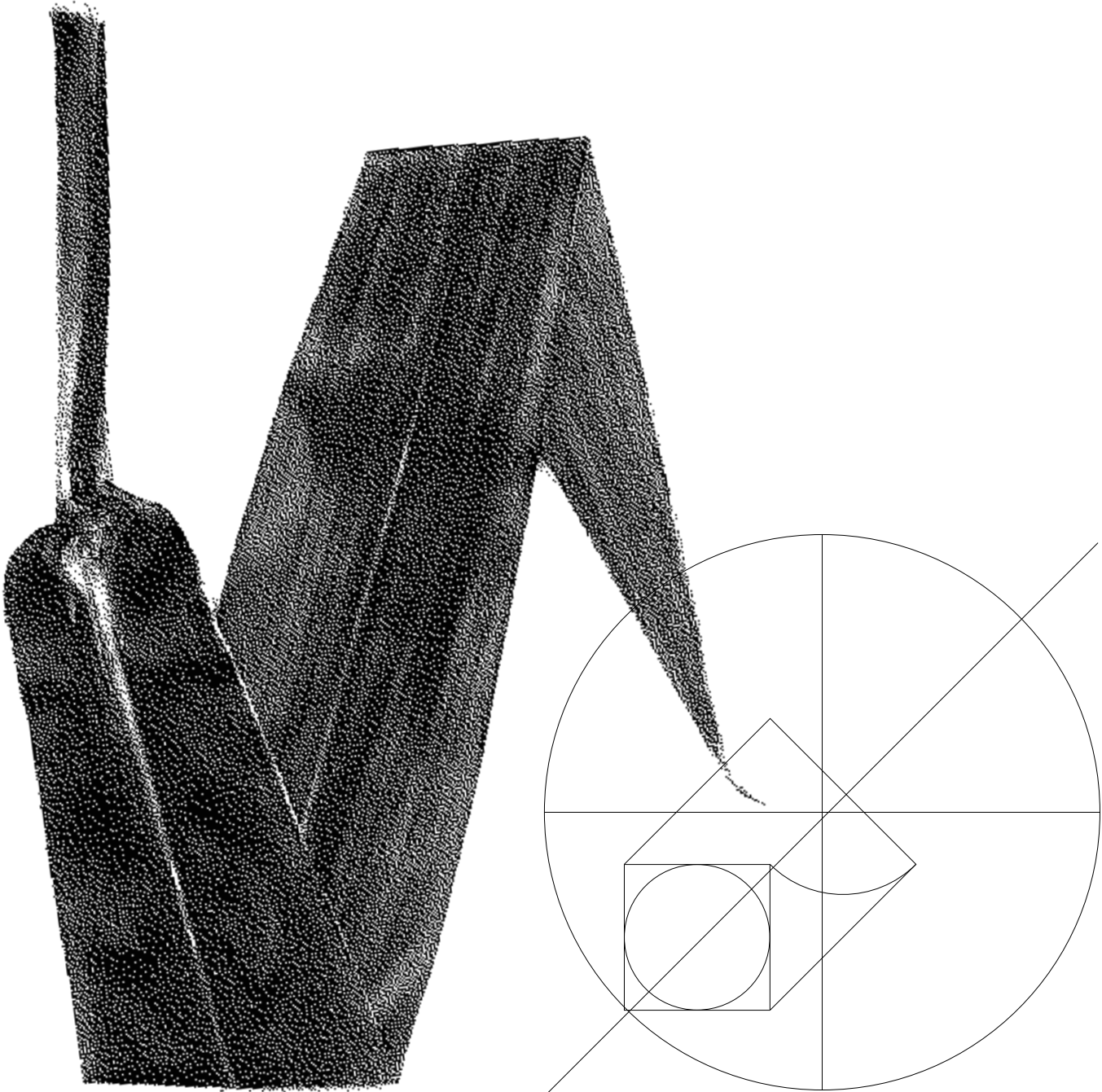



Axy

Designed by Claudio Bellini

EN Lightness and dynamism are the two values underlying Claudio Bellini's Axy table system. A fascinating encounter of different materials - the aluminium supporting frame is accompanied by a thin ceramic top in Pietra di Savoia, black and light grey calce. The design's pivotal point is its frame, which is architecturally essential and gives the table a feeling of lightness. Available in different sizes for outdoor use, it lends itself naturally to various interpretations in residential or contract settings.

IT Leggerezza e dinamicità: questi i due valori alla base del sistema di tavoli Axy di Claudio Bellini. Un suggestivo incontro di materiali diversi: la struttura portante in alluminio è accompagnata da un sottile top in ceramica nelle finiture pietra di Savoia, calce nero e calce grigio chiaro. Punto cardine del progetto è proprio il telaio, che si presenta come un'architettura essenziale, conferendo al tavolo una sensazione di leggerezza. Disponibile in svariate dimensioni per outdoor, si presta con naturalezza a diverse interpretazioni in ambito residenziale oppure contract.

← Axy with light grey calce top and matt painted white structure.

1 Axy, different sizes for outdoor use.



1



Fossil

Designed by Xavier Lust

EN Halfway between a sculpture and a piece of furniture, Fossil is a coffee table that works on the white concrete organic form and textural soul. Available in three sizes, Fossil can be used individually or in groups to create different compositions. Its design inspired by matter suggests the natural universe, which is why it finds its perfect place in any outdoor setting.

IT A metà tra una scultura e un complemento d'arredo, Fossil è un tavolino che lavora sulla forma organica e sull'anima materica del cemento bianco. Disponibile in tre diverse dimensioni, Fossil può essere utilizzato singolarmente oppure in gruppo per dare vita a diverse composizioni. Il suo design ispirato alla materia rievoca l'universo naturale, per questo motivo trova la sua perfetta collocazione in qualsiasi ambiente outdoor.

← Fossil low table, overview of the entire collection.

1 Fossil low table in Cement UHPFRC, ultra-high performance fibre-reinforced cement.



1

La Grande Table

Designed by Xavier Lust

→ La Grande Table in matt painted white finish.

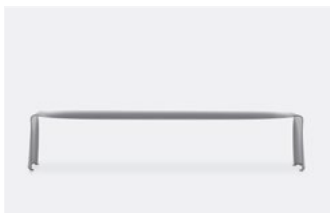

Le Banc



← La Grande Table is made from a single curved and painted aluminium sheet.

1 La Grande Table with Le Banc bench designed by Xavier Lust.



1

EN Exceeding the limits of matter by researching production systems that allow the creation of objects with innovative volumes is Xavier Lust's creative approach. His La Grande Table is a table made from a single 6-mm thick curved and painted aluminium sheet. Available in three finishes, La Grande Table reaches a length of 3.6 metres, accommodating up to ten people. Essentiality and timeless design allow this table to fit into a wide range of outdoor settings, gardens, terraces and patios, while maintaining its strong identity.

IT Superare i limiti della materia mediante la ricerca di sistemi di produzione che consentono di creare oggetti dai volumi innovativi è l'approccio creativo che contraddistingue i lavori di Xavier Lust. Porta la sua firma La Grande Table, un tavolo realizzato da un unico foglio di alluminio, curvato e verniciato, di soli 6 mm di spessore. Disponibile in tre finiture, La Grande Table raggiunge i 3,6 metri di lunghezza, accogliendo fino a dieci persone. Essenzialità e design senza tempo permettono a questo tavolo di inserirsi nei più svariati contesti outdoor, giardini, terrazze e dehors, mantenendo sempre forte la sua identità.



La Table Basse

Designed by Xavier Lust

EN Like La Grande Table and Le Banc, La Table Basse is a small table that completes the range. It is created using a 6-mm thick curved and painted aluminium sheet. The table's longitudinal and transverse curving, obtained by machining the aluminium sheet, is an integral part of the table's uniqueness. Its contemporary lines and matt white and aluminium finishes make it a suitable piece of furniture for any outdoor living space.

IT Come La Grande Table e Le Banc, anche La Table Basse, tavolino che completa la gamma, è creato con una lastra di alluminio di 6 mm di spessore, curvata e verniciata. Le curvature longitudinali e trasversali del tavolo, ottenute mediante la lavorazione della lastra di alluminio, sono parte integrante dell'identità del tavolino. Le finiture opache bianco e alluminio lo rendono un complemento adatto ad inserirsi in qualsiasi living all'aperto, caratterizzandolo con le sue linee contemporanee.

← La Table Basse in the aluminium matt painted finish.



Offset

Designed by Francesco Meda
David Lopez Quincoces



← Offset table matt painted lead black structure and bright sage green reconstructed stone top.



Neil Twist collection



EN The Offset table designed by the Meda-Quincoces designers duo finds its poetic ethos in minimalism. Pure material is the main element of this table system available in different sizes for outdoor use. The brushed anodised or matt lead black painted aluminium structure accommodates a top in reconstructed stone in different colours.

IT Il tavolo Offset, disegnato dalla coppia Meda-Quincoces, individua nella riduzione ad minimum la sua poetica. Un sistema di tavoli disponibile in diverse dimensioni per l'outdoor in cui protagonista è la materia pura. La struttura in alluminio anodizzato spazzolato o verniciato opaco nero piombo accoglie un top in pietra ricostruita in diverse tonalità di colore.

1 Offset table brushed anodised aluminium structure and black slate reconstructed stone top.

→ Offset table brushed anodised aluminium structure and brick red reconstructed stone top.



1





← Reconstructed stone, this particular finish is a mineral compound composed of marble and quartz.

→ Offset table, reconstructed stone detail.



Neil Twist collection

Rock Table Round
Rock Table Oval
Rock Table Mini
Rock Table Maxi

Rock Table collection

Designed by Jean Marie Massaud

EN Rock Table is Jean Marie Massaud's iconic collection of concrete tables with a tapered, elegant silhouette, with a solid central base and a slender top that appears to float. A range composed of round tables in various heights and sizes to respond to different uses – coffee, dining and high tables, an additional oval variant with a double base, and Rock Table Maxi, featuring a rectangular top with rounded corners. The natural, anthracite and stone chip cement finishes inspired by the colours of nature blend in harmony with their surroundings.

IT Rock Table è l'iconica collezione di tavoli in cemento di Jean Marie Massaud dalla silhouette affusolata ed elegante, caratterizzata da un solido basamento centrale e da un sottile piano che sembra fluttuare. Una famiglia composta da tavoli rotondi in più altezze e dimensioni per rispondere alle diverse situazioni d'uso – coffee tables, tavolo da pranzo e tavolo alto – a cui si aggiungono la variante ovale con doppio basamento, e Rock Table Maxi, caratterizzato da un top rettangolare con angoli smussati. Le finiture in cemento naturale, antracite e in cemento granigliato ispirate ai colori della natura si fondono in armonia con l'ambiente circostante.



← Rock Table Round green stone chip cement top and cement green base.



→ Rock Table Oval in green stone chip cement top and two bases in cement green.



Neil Twist collection





→ Rock Table Round in terracotta stone chip cement top and cement terracotta base.

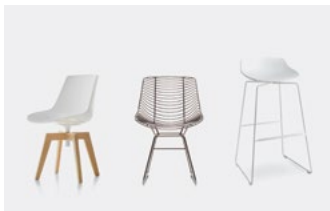

Flow collection





← Rock Table Maxi, with white cement top.

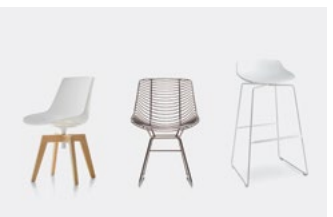

Flow collection



→ Rock Table Round, height 110 cm.



Neil Twist collection



← Rock Table Mini, coffee tables with white cement top and cement natural base.



Tense Outdoor

Designed by Piergiorgio & Michele Cazzaniga



← Tense Outdoor in reconstructed stone.

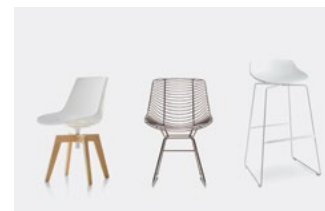

Flow collection





EN Piergiorgio and Michele Cazzaniga's Tense Outdoor is the result of extensive research into the most suitable materials for outdoor spaces. Completely made of aluminium, the iconic table for the outdoor collection is available in four sizes. In the mono-material version it is covered in aluminium sheet and painted in different colours. The finishes in reconstructed white Calce, black Slate, yellow and pink Onyx, sage green, brick red and Pietra Serena create unique textures for each table.

IT Da una lunga ricerca sui materiali più idonei agli spazi esterni nasce Tense Outdoor, di Piergiorgio e Michele Cazzaniga. Completamente in alluminio, l'iconico tavolo della collezione per outdoor è disponibile in quattro dimensioni. Nella versione monomaterica è completamente rivestito in lamiera di alluminio e verniciato in diversi colori. Le finiture materiche nelle pietre ricostruite bianco Calce, nero Ardesia, Onice giallo, Onice rosa, verde salvia, rosso mattone e pietra Serena danno vita a texture uniche che caratterizzano ogni singolo tavolo.

← Tense Outdoor in reconstructed stone yellow onyx.

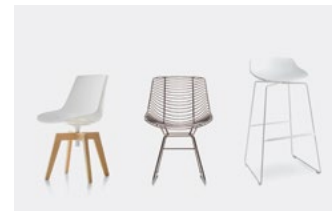

Flow collection

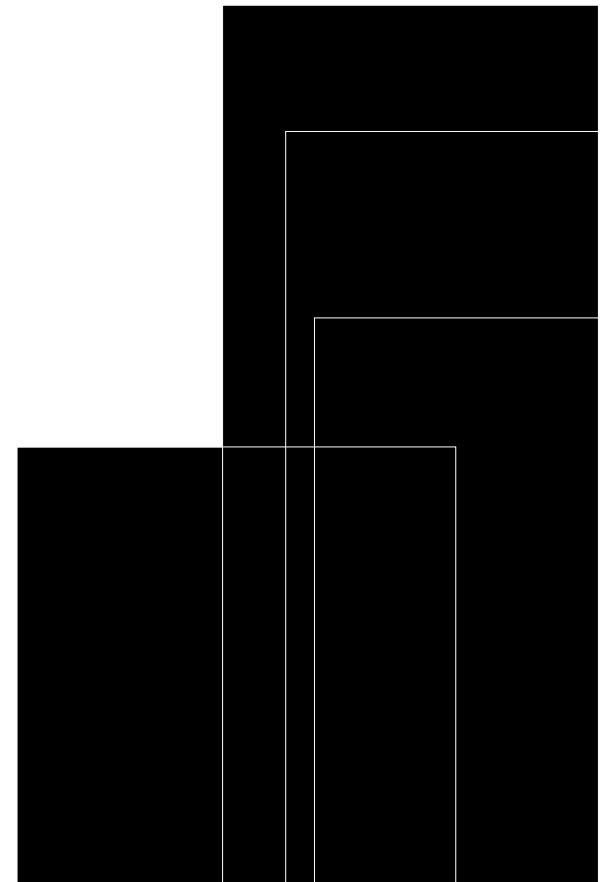

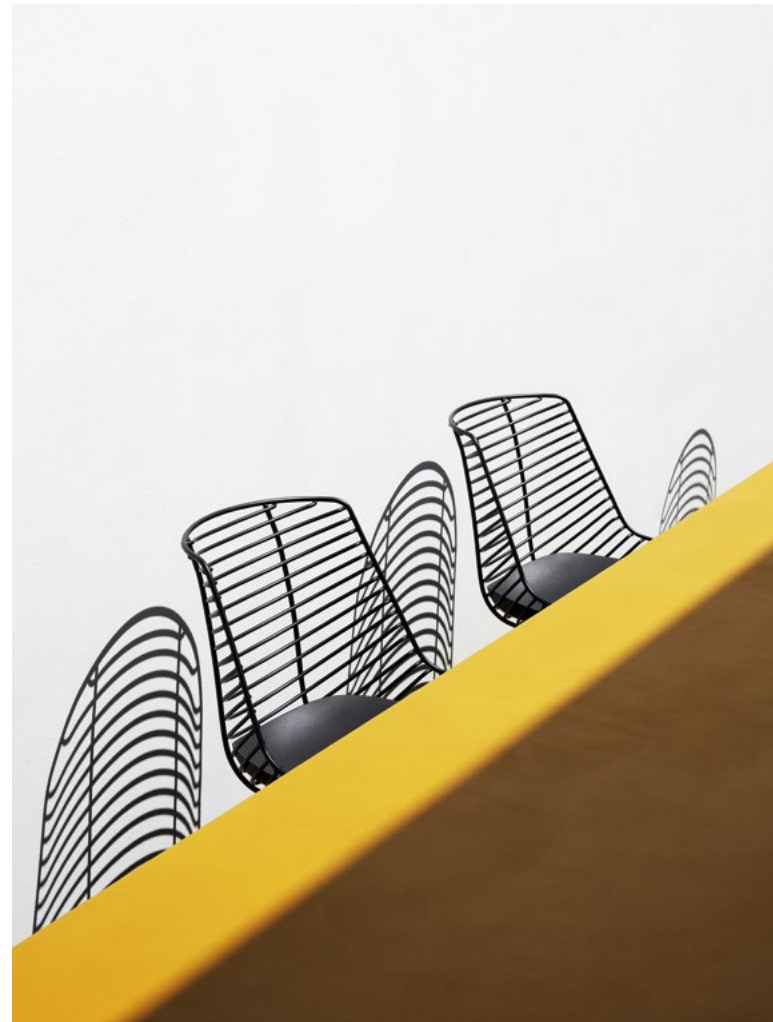

→ Tense Outdoor, detail of the 35×35 mm leg section.

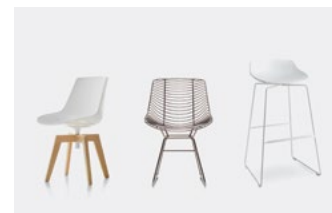

Flow collection



1

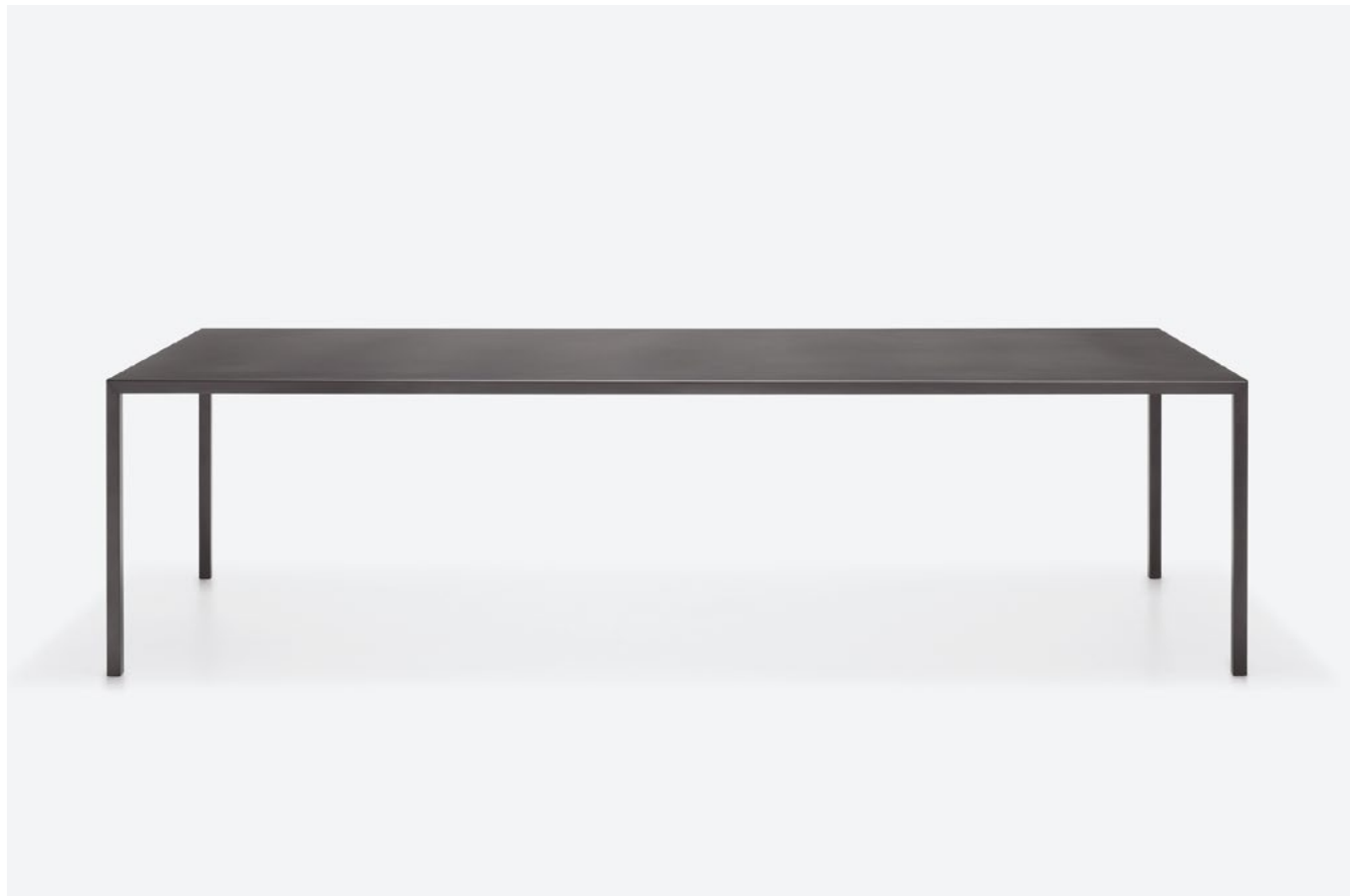

2

1-2 Tense Outdoor in reconstructed stone black slate.

3-5 Tense Outdoor goffered painted finish in different colours.

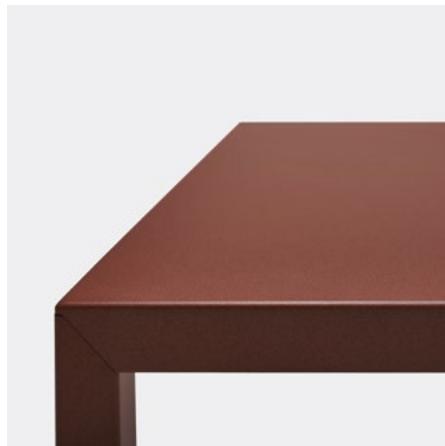

3

105



4



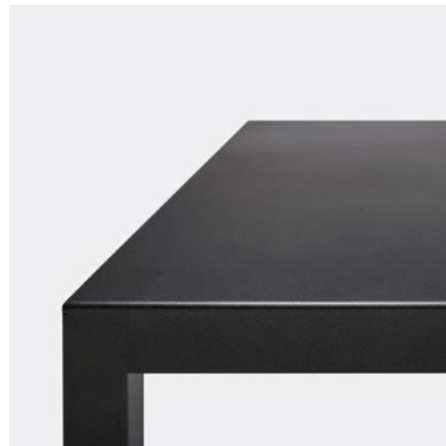



MDF Italia

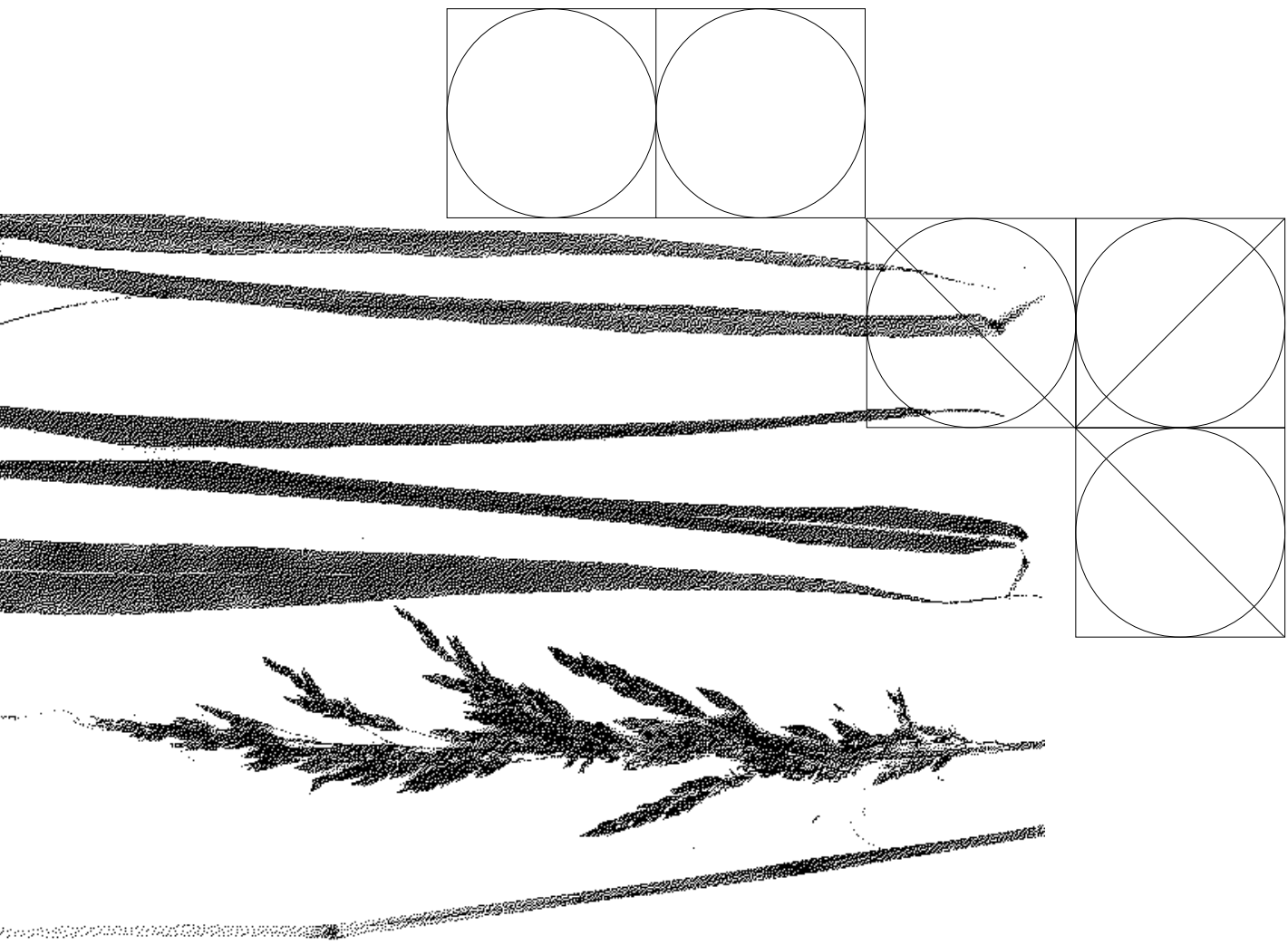

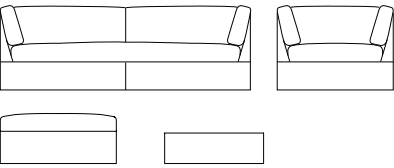

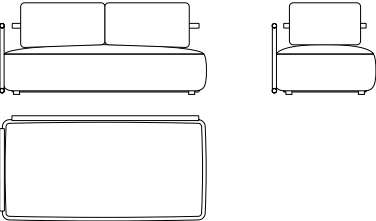









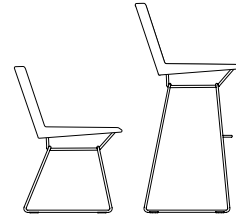

5

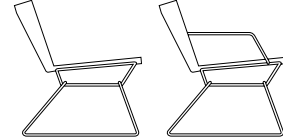

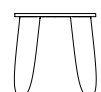

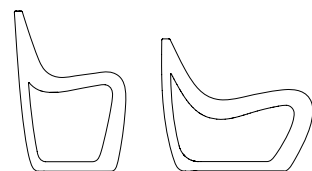





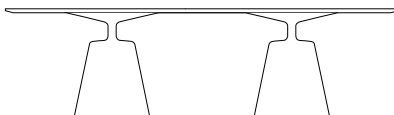



Outdoor book

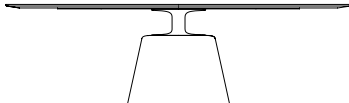

<h3>Arpa Collection</h3> 	Discover all sizes on the website.	Outdoor covering tarpaulin.  Structure 
<h3>Cosy Outdoor</h3> 	Discover all sizes on the website.	Outdoor covering tarpaulin.  Structure 
<p>Chairs, armchairs, bench and stools</p>		
<h3>Flow Iroko</h3> 	L54 D56.5 H80.5 seat H44	Outdoor covering tarpaulin.  Shell and base 
<h3>Flow Filo</h3> 	Chair L53.2 D55.6 H80.5 seat H44 weight 8.2 kg Slim L56.8 D55.6 H76.5 seat H44 armrest H67 weight 8.6 kg Indoor/outdoor pad in polyurethane backrest L23 H39 seat L45 D45	Outdoor covering tarpaulin.  Steel rods  Polyurethane pad
<h3>Flow Stool</h3> 	L52 D48 H78 L52 D48 H65	Outdoor covering tarpaulin.  Shell  Base

<h3>Le Banc</h3> 	Bench L120 D40 H44 L170 D40 H44 L220 D40 H44	Outdoor covering tarpaulin.  Shell 
<h3>M1</h3> 	L54 D49.7 H75.7 seat H44 weight 4.2 kg	Outdoor covering tarpaulin.  Shell  Base
<h3>Neil Twist chair and stool</h3> 	L50 D58 H80 seat H45 Stool L50 D58 H96 seat H65 L50 D58 H107 seat H78	Outdoor covering tarpaulin.  Frame  Shell rope
<h3>Neil Twist armchair</h3> 	Armchair L75.2 D66 H71 seat H41.3 Armchair, with armrest L79.6 D66 H71 seat H41.3	Outdoor covering tarpaulin.  Frame  Shell rope
<h3>Sag</h3> 	Ø40 H44 polyurethane version	Outdoor covering tarpaulin.  Structure and top 
<h3>Sign Matt</h3> 	Chair L48 D51.5 H74.5 seat H47 weight 10 kg Armchair L72 D71 H62 seat H38.5 weight 20 kg	Available with dripping hole.  Structure 

<p>Axy</p> 	<p>H73 Axy D80 L200, 220, 240 D90 L200, 220, 240, 260 H73 Axy Comfort D90 L240, 260, 280 D100 L240, 260, 280, 300 D120 L240, 260, 280, 300</p>	<p>Outdoor covering tarpaulin.</p>  <p>Top</p>  <p>Frame</p> 
<p>Fossil</p> 	<p>Fossil low table S L45 D64 H32 Fossil low table M L36 D50 H42 Fossil low table L L36 D50 H52</p>	<p>Outdoor covering tarpaulin.</p>  <p>Cement top and base</p> 
<p>La Grande Table</p> 	<p>H73 D80 L220, 240 D90 L280, 320, 360</p>	<p>Outdoor covering tarpaulin.</p>  <p>Structure</p> 
<p>La Table Basse</p> 	<p>L94 D90 H27 L125 D90 H27</p>	<p>Outdoor covering tarpaulin.</p>  <p>Structure</p> 
<p>Offset</p> 	<p>H73 D100 L180, 240, 300 D120 L120 D148 L148 D180 L180</p>	<p>Outdoor covering tarpaulin.</p>  <p>Structure</p>  <p>Top</p> 
<p>Rock Table Round</p> 	<p>Round top, narrow base Ø80 H72 Ø80 H110 Ø100 H72 Round top, wide base Ø120 H72 Ø140 H72</p>	<p>Outdoor covering tarpaulin.</p>  <p>Top</p>  <p>Base</p> 

<p>Rock Table Oval</p> 	<p>Oval top, double base L250 D125 L300 D145</p>	<p>Outdoor covering tarpaulin.</p>  <p>Top</p>  <p>Base</p> 
<p>Rock Table Mini</p> 	<p>Ø60 H53 Ø80 H46 Ø100 H39</p>	<p>Outdoor covering tarpaulin.</p>  <p>Top</p>  <p>Base</p> 
<p>Rock Table Maxi</p> 	<p>H73 L210 D105 H72 L240 D115 H72</p>	<p>Outdoor covering tarpaulin.</p>  <p>Top</p>  <p>Base</p> 
<p>Tense Outdoor</p> 	<p>H75 D90 L180 D100 L240 D120 L280 D140 L140</p>	<p>Outdoor covering tarpaulin.</p>  <p>Top</p> 

Credits

Graphic design
Studio CCRZ

Photo
Lorenzo Cappelini Baio
Studio Controluce
Thomas Pagani

Styling
Enrico Pompili
Valentina Cameranesi
Paola Pastorini Studio
con Simona Pozzi

Text
Communication & Marketing
MDF Italia
Ludovica Niero
Cosimo Bizzarri
Lisa Cadamuro

MDF Italia Srl Società Unipersonale
Headquarters

Via Fratelli Cervi 4/A
22066 Mariano Comense (CO)

© 2024
MDF Italia all rights reserved
MDF Italia reserves the right to change,
at any time and without prior warning,
the technical specifications of any products
illustrated in this catalogue.

www.mdffitalia.it



Discover the
Outdoor products

Follow us



mdf italia

